

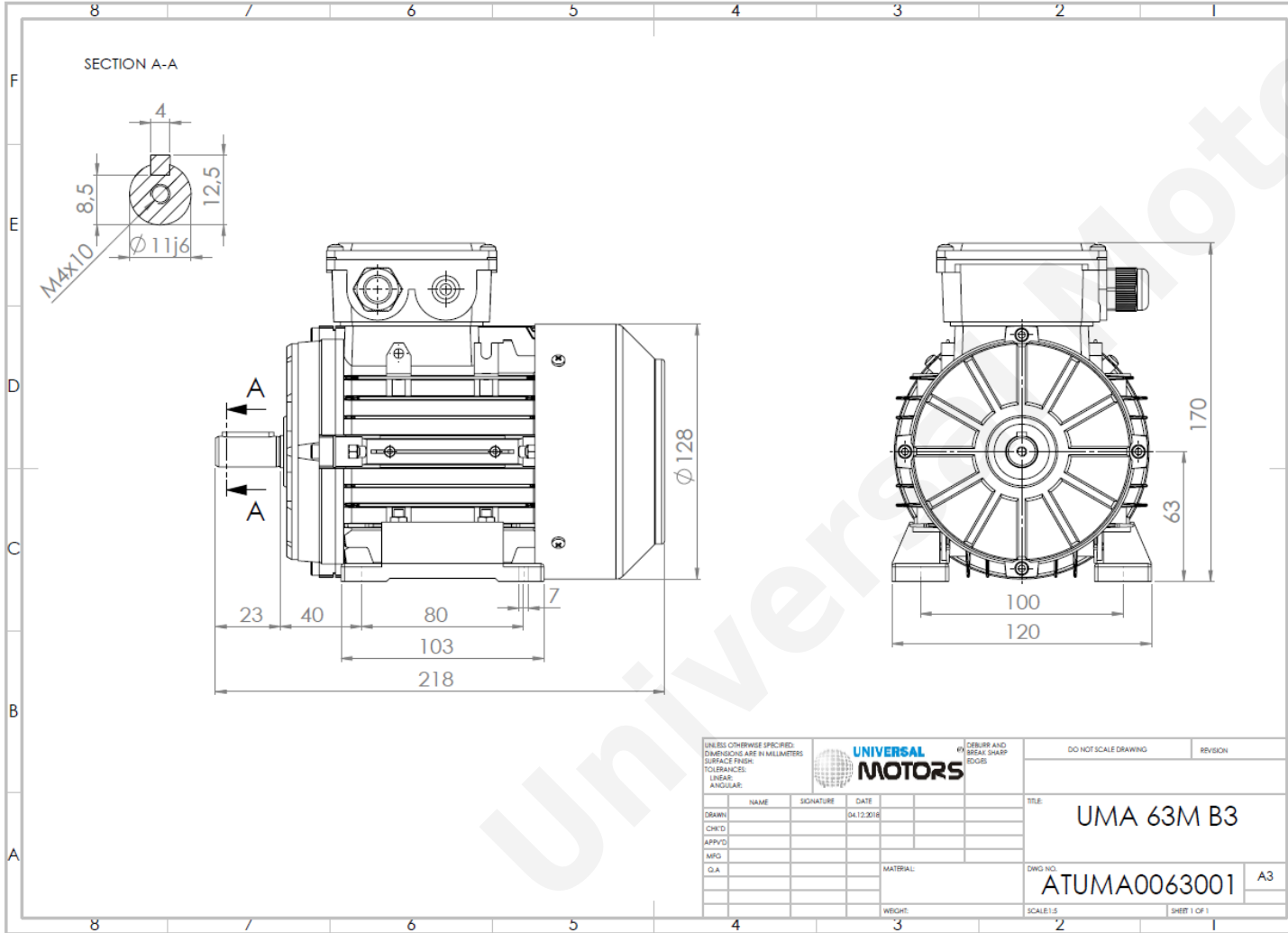

TECHNICAL DATA

Three Phase Electric Motors - Aluminum Frame
 UM2A 63M3-2
 0.37 kW / 0.50 Cv
 2840 RPM



Motor type:	UM2A 63M3-2
Output:	0.37 kW / 0.50 Cv
Speed (min ⁻¹):	2840 RPM
Frequency:	50 Hz
Voltage:	400 V
Current:	0.98 A
Power factor (Cos Ø):	0.78
Poles:	2
Insulation class:	F
Temperature rise Class:	B
Efficiency 50%:	62.6 %
Efficiency 75%:	68.5 %
Efficiency 100%:	69.8 %
Torque:	1.24 N.m
Tstarting/Tnominal:	2.0
Istarting/Inominal:	5.1
Tmaximum/Tnominal:	2.4
Noise:	62 Db(A)
Weight:	4.6 Kg
Bearing DE:	6201 2Z
Bearing NDE:	6201 2Z

Regime - S1

Altitude - 1000m

Environment Temperature - 40°C

CONTACTS:

UNIVERSAL MOTORS Tel: +351 252 299 080
 Rua de São Brás,745 Fax: +351 252 299 089
 4480-782 VILA DO CONDE Mail: geral@universalmotors.pt

* References applied only in the UK